

# Process resistance thermometer Model TR12-B, for additional thermowell Model TR12-M, basic module

WIKA data sheet TE 60.17



for further approvals  
see page 2

## Applications

- Chemical industry
- Petrochemical industry
- Offshore
- Plant and vessel construction

## Special features

- For many variants of temperature transmitters including field transmitter
- For mounting in all standard thermowell designs
- Spring-loaded measuring insert (replaceable)
- Explosion-protected versions

## Description

Resistance thermometers in this series can be combined with a large number of thermowell designs. The replaceable, centrally spring-loaded measuring insert and its extended spring travel enable combination with the widest range of connection head designs.

A wide variety of possible combinations of sensor, connection head, insertion length, neck length, connection to thermowell etc. are available for the thermometers; suitable for any thermowell dimension and any application.

Operation without thermowell is only recommended in certain applications.



**Fig. left: Process resistance thermometer model TR12-B**  
**Fig. right: Basic module model TR12-M**

## Explosion protection (option)

For application in hazardous areas, corresponding versions are available.

### Intrinsic safety

These instruments comply with the requirements of the ATEX directive or IECEx for gas.





### Flameproof enclosure







These instruments comply with the requirements of the ATEX directive or IECEx for gas.

The permissible power  $P_{max}$  as well as the permissible ambient temperature for the respective category can be seen on the EC-type examination certificate or else the IECEx certificate or the operating instructions.

Built-in transmitters have their own EC-type examination certificate. The permissible ambient temperature ranges of the built-in transmitters can be taken from the corresponding transmitter approval.

## Approvals (explosion protection, further approvals)

Logo	Description	Country
	<b>EU declaration of conformity</b> <ul style="list-style-type: none"> <li>■ EMC directive <sup>1)</sup> EN 61326 emission (group 1, class B) and interference immunity (industrial application)</li> <li>■ ATEX directive (option) Hazardous areas               <ul style="list-style-type: none"> <li>- Ex i Zone 0 gas [II 1G Ex ia IIC T3 ... T6 Ga]</li> <li>Zone 1 mounting to zone 0 gas [II 1/2G Ex ia IIC T3 ... T6 Ga/Gb]</li> <li>Zone 1 gas [II 2G Ex ia IIC T3 ... T6 Gb]</li> <li>- Ex d Zone 1 mounting to zone 0 gas [II 1/2D Ex db IIC T1 ... T6]</li> <li>Zone 1 gas [II 2G Ex db IIC T1 ... T6]</li> </ul> </li> </ul>	European Union
		
	<b>IECEx (option)</b> (in conjunction with ATEX) Hazardous areas <ul style="list-style-type: none"> <li>- Ex i Zone 0 gas [Ex ia IIC T3 ... T6 Ga]</li> <li>Zone 1 mounting to zone 0 gas [Ex ia IIC T3 ... T6 Ga/Gb]</li> <li>Zone 1 gas [Ex ia IIC T3 ... T6 Gb]</li> <li>- Ex d Zone 1 mounting to zone 0 gas [Ex db IIC T1 ... T6 Ga/Gb]</li> <li>Zone 1 gas [Ex db IIC T1 ... T6 Gb]</li> </ul>	International
	<b>EAC (option)</b> Hazardous areas <ul style="list-style-type: none"> <li>- Ex i Zone 0 gas [0 Ex ia IIC T3/T4/T5/T6]</li> <li>Zone 1 gas [1 Ex ib IIC T3/T4/T5/T6]</li> <li>Zone 20 dust <sup>2)</sup> [DIP A20 Ta 65 °C/Ta 95 °C/Ta 125 °C]</li> <li>Zone 21 dust <sup>2)</sup> [DIP A21 Ta 65 °C/Ta 95 °C/Ta 125 °C]</li> <li>- Ex d Zone 1 gas [1 Ex d IIC T6 ... T1]</li> </ul>	Eurasian Economic Community
	<b>INMETRO (option)</b> Hazardous areas <ul style="list-style-type: none"> <li>- Ex i Zone 0 gas [Ex ia IIC T3 ... T6 Ga]</li> <li>Zone 1 mounting to zone 0 gas [Ex ib IIC T3 ... T6 Ga/Gb]</li> <li>Zone 1 gas [Ex ib IIC T3 ... T6 Gb]</li> <li>Zone 20 dust <sup>2)</sup> [Ex ia IIIC T125 ... T65 °C Da]</li> <li>Zone 21 mounting to zone 20 dust <sup>2)</sup> [Ex ib IIIC T125 ... T65 °C Da/Db]</li> <li>Zone 21 dust <sup>2)</sup> [Ex ib IIIC T125 ... T65 °C Db]</li> <li>- Ex d Zone 1 mounting to zone 0 gas [Ex d IIC T* Ga/Gb]</li> <li>Zone 1 gas [Ex d IIC T* Gb]</li> </ul>	Brazil

Logo	Description	Country
	<b>NEPSI (option)</b> Hazardous areas - Ex i Zone 0 gas [Ex ia IIC T3 ~ T6] Zone 1 mounting to zone 0 gas [Ex ia/ib IIC T3 ~ T6] Zone 1 gas [Ex ib IIC T3 ~ T6] Zone 20 dust <sup>2)</sup> [Ex iaD 20 T65 ~ T125] Zone 21 mounting to zone 20 dust <sup>2)</sup> [Ex ibD 20/21 T65 ~ T125] Zone 21 dust <sup>2)</sup> [Ex ibD 21 T65 ~ T125]	China
	<b>KCs - KOSHA (option)</b> Hazardous areas - Ex i Zone 0 gas [Ex ia IIC T4 ... T6] Zone 1 gas [Ex ib IIC T4 ... T6]	South Korea
-	<b>PESO (option)</b> Hazardous areas - Ex i Zone 0 gas [Ex ia IIC T1 ... T6 Ga] Zone 1 mounting to zone 0 gas [Ex ib IIC T3 ... T6 Ga/Gb] Zone 1 gas [Ex ib IIC T3 ... T6 Gb] - Ex d Zone 1 gas [Ex d IIC T1 ... T6 Gb]	India
	<b>DNOP - MakNII (option)</b> Hazardous areas - Ex i Zone 0 gas <sup>2)</sup> [II 1G Ex ia IIC T3, T4, T5, T6 Ga] Zone 1 mounting to zone 0 gas <sup>2)</sup> [II 1/2G Ex ib IIC T3, T4, T5, T6 Ga/Gb] Zone 1 gas <sup>2)</sup> [II 2G Ex ib IIC T3, T4, T5, T6 Gb] Zone 20 dust <sup>2)</sup> [II 1D Ex ia IIIC T65, T95, T125 °C Da] Zone 21 mounting to zone 20 dust <sup>2)</sup> [II 1/2D Ex ib IIIC T65, T95, T125 °C Da/Db] Zone 21 dust <sup>2)</sup> [II 2D Ex ib IIIC T125 ... T65 °C Db]	Ukraine
	<b>GOST (option)</b> Metrology, measurement technology	Russia
	<b>KazInMetr (option)</b> Metrology, measurement technology	Kazakhstan
-	<b>MTSCHS (option)</b> Permission for commissioning	Kazakhstan
	<b>BelGIM (option)</b> Metrology, measurement technology	Belarus
	<b>Uzstandard (option)</b> Metrology, measurement technology	Uzbekistan

## Manufacturer's information and certificates

Logo	Description
	<b>SIL 2</b> Functional safety

- 1) Only for built-in transmitter  
2) Only for model TR12-B

Instruments marked with "ia" may also be used in areas only requiring instruments marked with "ib" or "ic".  
If an instrument with "ia" marking has been used in an area with requirements in accordance with "ib" or "ic", it can no longer be operated in areas with requirements in accordance with "ia" afterwards.

Approvals and certificates, see website

## Specifications

Output signal Pt100			
Temperature range	Measuring range -200 ... +600 °C		
Measuring element (measuring current: 0.1 ... 1.0 mA)	Pt100 measuring resistor		
Connection method	1 x 2-wire 1 x 3-wire 1 x 4-wire 2 x 2-wire 2 x 3-wire 2 x 4-wire		
Tolerance value of the measuring element <sup>1)</sup> per EN 60751		Wire-wound	Thin film
	Class B	-200 ... +600 °C	-50 ... +500 °C
	Class A	-100 ... +450 °C	-30 ... +300 °C
	Class AA	-50 ... +250 °C	0 ... 150 °C

Output signal 4 ... 20 mA, HART® protocol, FOUNDATION™ Fieldbus and PROFIBUS® PA				
Transmitter (selectable versions)	Model T15	Model T32	Model T53	Models TIF50, TIF52
Data sheet	TE 15.01	TE 32.04	TE 53.01	TE 62.01
<b>Output</b>				
■ 4 ... 20 mA	x	x		x
■ HART® protocol		x		x
■ FOUNDATION™ Fieldbus and PROFIBUS® PA			x	
<b>Connection method</b>				
■ 1 x 2-wire, 3-wire or 4-wire	x	x	x	x
<b>Measuring current</b>	< 0.2 mA	< 0.3 mA	< 0.2 mA	< 0.3 mA
<b>Explosion protection</b>	Optional	Optional	Standard	Standard

Measuring insert (replaceable)	
<b>Material</b>	Stainless steel 1.4571, 316/316L
<b>Diameter</b>	Standard: 3 mm <sup>2)</sup> , 6 mm, 8 mm (with sleeve) Option (on request): 1/8 inch <sup>2)</sup> (3.17 mm), 1/4 inch (6.35 mm), 3/8 inch (9.53 mm)
<b>Spring travel</b>	approx. 20 mm
<b>Response time</b> (in water, per EN 60751)	t <sub>50</sub> < 10 s    t <sub>90</sub> < 20 s (measuring insert diameter 6 mm: The thermowell required for operation increases the response time dependent upon the actual parameters for the thermowell and the process.)

Neck tube	
<b>Material</b>	Stainless steel 316/316L/316Ti
<b>Connection thread to the thermowell</b>	<ul style="list-style-type: none"> <li>■ G 1/2 B</li> <li>■ G 3/4 B</li> <li>■ 1/2 NPT</li> <li>■ 3/4 NPT</li> <li>■ M14 x 1.5</li> <li>■ M18 x 1.5</li> <li>■ M20 x 1.5</li> <li>■ M27 x 2</li> </ul>
<b>Connection thread to the head</b>	<ul style="list-style-type: none"> <li>■ M20 x 1.5 with counter nut</li> <li>■ 1/2 NPT</li> </ul>
<b>Neck length</b>	<ul style="list-style-type: none"> <li>■ min. 150 mm, standard neck length</li> <li>■ 200 mm</li> <li>■ 250 mm</li> <li>other neck lengths on request</li> </ul>

Use resistance thermometers with shielded cable, and, if the lines are longer than 30 m or leave the building, ground the shield on at least one end of the lead. For a correct determination of the overall measuring deviation, both sensor and transmitter measuring deviations have to be considered.

1) For detailed specifications for Pt100 sensors, see Technical information IN 00.17 at [www.wika.com](http://www.wika.com).

2) Not for 2 x 4-wire connection method

Ambient conditions	
Ambient and storage temperature	-60 <sup>3)</sup> / -40 ... +80 °C
Ingress protection	IP66 per IEC/EN 60529 The specified ingress protection only applies for TR12-B with corresponding thermowell, connection head, cable gland and appropriate cable dimensions.
Vibration resistance	6 g peak-to-peak, wire-wound measuring resistor or thin film (standard) 20 g peak-to-peak, thin-film measuring resistor (option) 50 g peak-to-peak, thin-film measuring resistor (option) <sup>4)</sup>

3) Special version on request (only available with selected approvals), other ambient and storage temperature on request

4) For measuring insert diameter < 8 mm

## Measuring insert

The replaceable measuring insert is made of a vibration-resistant, sheathed measuring cable (MI cable).

The measuring insert diameter should be approx. 1 mm smaller than the bore diameter of the thermowell.

Gaps of more than 0.5 mm between thermowell and the measuring insert will have a negative effect on the heat transfer, and they will result in unfavourable response behaviour of the thermometer.

When fitting the measuring insert into a thermowell, it is very important to determine the correct insertion length (= thermowell length for bottom thicknesses of  $\leq 5.5$  mm). In order to ensure that the measuring insert is firmly pressed down onto the bottom of the thermowell, the insert must be spring-loaded (spring travel: 0 ... 20 mm).

### Calculation of the measuring insert length in the event of replacement

Thread to connection head	Measuring insert length $l_5$
1/2 NPT	NL + 12 mm
M20 x 1.5	NL + 18 mm

NL = Nominal length of the TR12-B or TR12-M

## Neck tube

The neck tube is screwed into the connection head or the case. The neck length depends on the intended use. Usually an isolation is bridged by the neck tube. Also, in many cases, the neck tube serves as a cooling extension between the connection head and the medium, in order to protect any possible built-in transmitter from high medium temperatures.

In the Ex d version the flameproof joint is integrated in the neck tube.



## Thermowell selection

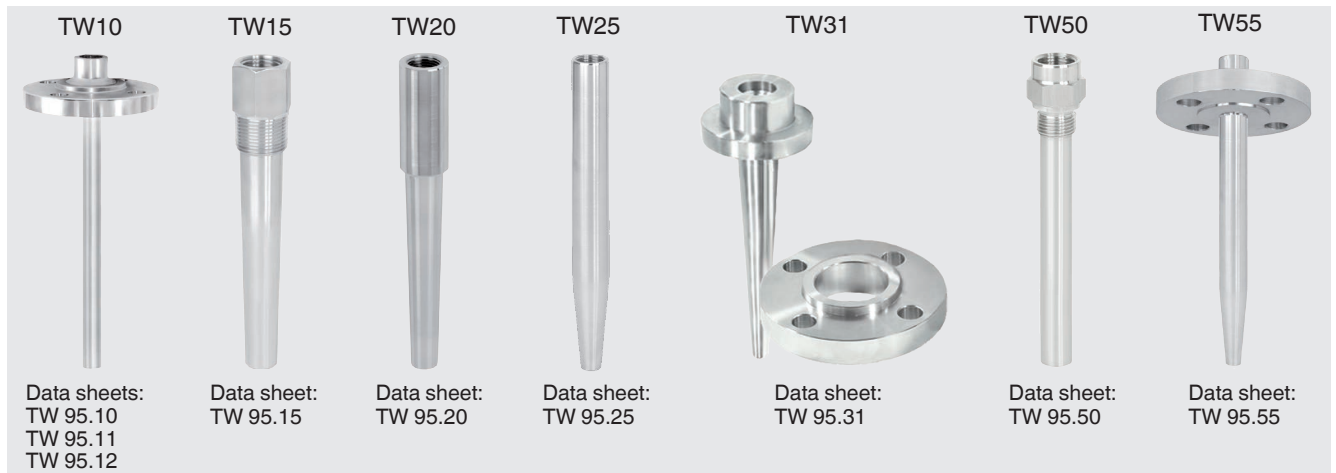

Special thermowells on request

## Connection head



1/4000

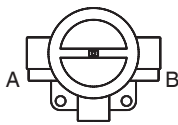

5/6000

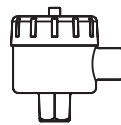

7/8000

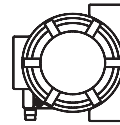

other connection  
housings

Model	Material	Cable outlet	Ingress protection	Explosion protection	Cap	Surface
1/4000 F	Aluminium	½ NPT, ¾ NPT, M20 x 1.5	IP66 <sup>1)</sup>	Without, Ex i, Ex d	Screw-on lid	Blue, lacquered <sup>2)</sup>
1/4000 S	Stainless steel	½ NPT, ¾ NPT, M20 x 1.5	IP66 <sup>1)</sup>	Without, Ex i, Ex d	Screw-on lid	Blank
5/6000	Aluminium	2 x ½ NPT, 2 x ¾ NPT, 2 x M20 x 1.5	IP66 <sup>1)</sup>	Without, Ex i, Ex d	Screw-on lid	Blue, lacquered <sup>2)</sup>
7/8000 W	Aluminium	½ NPT, ¾ NPT, M20 x 1.5	IP66 <sup>1)</sup>	Without, Ex i, Ex d	Screw-on lid	Blue, lacquered <sup>2)</sup>
7/8000 S	Stainless steel	½ NPT, ¾ NPT, M20 x 1.5	IP66 <sup>1)</sup>	Without, Ex i, Ex d	Screw-on lid	Blank

1) The specified ingress protection only applies for TR12-B with corresponding cable gland, appropriate cable dimensions and mounted thermowell.

2) RAL 5022

## Field temperature transmitter with digital display (option)

### Field temperature transmitters models TIF50, TIF52

As an alternative to the standard connection head the thermometer can be fitted with an optional model TIF50 or TIF52 field temperature transmitter.

The field temperature transmitter comprises a 4 ... 20 mA/ HART® protocol output and is equipped with an LCD indication module.

Model TIF50: HART® slave

Model TIF52: HART® master



Field temperature transmitters models TIF50, TIF52

## Transmitter (option)

As an option, WIKA transmitters can be installed in the TR12-B connection head.

Model	Description	Explosion protection	Data sheet
T15	Digital transmitter, PC configurable	Optional	TE 15.01
T32	Digital transmitter, HART® protocol	Optional	TE 32.04
T53	Digital transmitter FOUNDATION™ Fieldbus and PROFIBUS® PA	Standard	TE 53.01
TIF50	Digital field temperature transmitter, HART® protocol (slave)	Optional	TE 62.01
TIF52	Digital field temperature transmitter, HART® protocol (master)	Optional	TE 62.01

Other transmitters on request

## Electrical connection

(Colour code per IEC 60751)

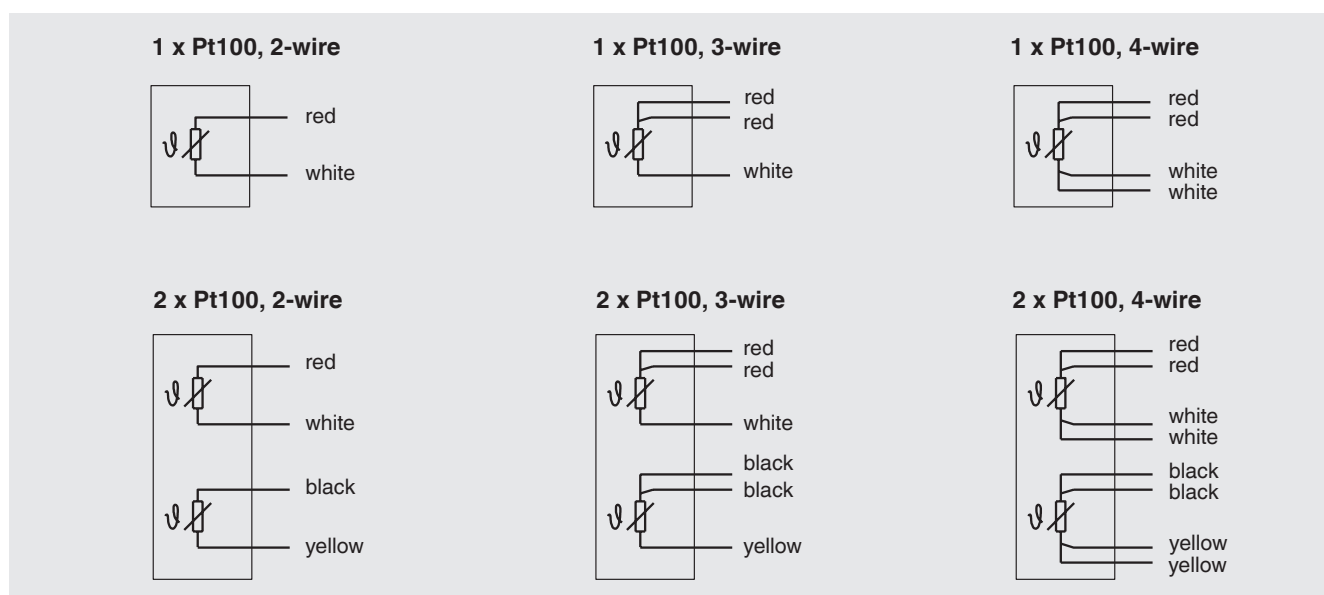

For the electrical connections of built-in temperature transmitters see the corresponding data sheets or operating instructions.



## Functional safety (option)

In safety-critical applications, the entire measuring chain must be taken into consideration in terms of the safety parameters. The SIL classification allows the assessment of the risk reduction reached by the safety installations.

Selected TR12 process resistance thermometers in combination with an appropriate temperature transmitter (e.g. model T32.1S) are suitable as sensors for safety functions up to SIL 2.

Matched thermowells allow easy dismounting of the measuring insert for calibration. The optimally matched measuring point consists of a thermowell, a TR12 thermometer and a T32.1S transmitter developed in accordance with IEC 61508. Thus, the measuring point provides maximum reliability and a long service life.

## Certificates (option)

Certification type	Measurement accuracy	Material certificate
2.2 test report	x	x
3.1 inspection certificate	x	-
DKD/DAkkS calibration certificate	x	-

The different certifications can be combined with each other.

Approvals and certificates, see website

## Ordering information

Model / Explosion protection / Ignition protection type / Sensor / Sensor specifications / Thermometer range of use / Connection housing / Thread size at cable outlet / Transmitter / Neck tube version / Connection to case, connection head / Connection to thermowell / Neck tube length N(MH) / Insertion length A / Measuring insert / Options

© 04/2011 WIKA Alexander Wiegand SE & Co. KG, all rights reserved.  
The specifications given in this document represent the state of engineering at the time of publishing.  
We reserve the right to make modifications to the specifications and materials.

