

Styli for Zeiss applications



Contents

Page

Renishaw M5 styli, adaptors and accessories for Zeiss analogue probe systems without probe changing

Standard probe (tungsten carbide)	4
Swivel piece with cone	4
Adaptor with cone	4
Adaptor	5
Holder with cone	5

Renishaw M5 styli, adaptors and accessories for Zeiss measuring probe head with probe changer and dynamic probe head (with or without probe changer)

Standard styli (tungsten carbide)	6
Standard styli (ceramic)	6
Styli (general)	7
Fine styli	7
Cube stars	7
Styli for thread measurement	8
Styli for star styli and multi-styli mounting plates (tungsten carbide)	8
Clamping disc for star styli (tungsten carbide)	9
Slot disc for star styli	9
Tungsten carbide pin for star styli	9
Mounting support for star styli	10
Rotational adjustment piece	10
Holder for styli (d = 1....1.5 mm)	10
Holder for 5 styli (maximum)	11
Styli (for universal 3D probe head only) (tungsten carbide)	11
Styli (tungsten carbide)	11
Holder for swivel styli	12
Swivel styli (tungsten carbide)	12
Spherical disc styli	12
Extensions (aluminium)	13
Extensions (stainless steel)	13
Extensions (titanium)	14

Extensions (carbon fibre)	15
Cubes	15
Double cube (titanium)	16
Stylus discs (hardened steel)	16
Thread styli	17
Star stylus	17
Pointed stylus	17
Cube extension	18
Joint (titanium)	18
Multi-styli mounting plate (for Zeiss MT and VAST probe heads only)	18
Bolts for spherical disk and cube (stainless steel)	19
Bolts for cubes (stainless steel)	19

Renishaw adaptors for the assembly of M2, M3 and M5 styli to Zeiss measuring probe heads

Adaptor	20
Digitizer adaptor	20

Renishaw tools and accessories for the assembly of M2, M3 and M5 styli to Zeiss measuring probe heads

Stylus tool (M2 and M3 styli)	21
Allen keys DIN 911	21
Toolkit	21
Stylus toolset, consisting of two 2 pin-type 2.9	21
Stylus tool 1.7 for M5	21
Pin-type spanner 2.9 for M5	21
Assortment of screws:	22
Spring-lock washers	22
C spanners DIN 1810	22

Renishaw adaptor plates for Zeiss probe heads

M-SYS adaptor plates:	23
Adaptor plate (with disc and roller, but without cube)	23
Adaptor plate (titanium)	24
Adaptor plates (S-SYS):	24

Adaptor plates (Prismo):	25
Adaptor plates (Prismo VAST)	25

Renishaw adaptor elements for Zeiss RST probe systems with M2/M3 connecting thread

M3 styli	27
M2 styli	27
M3 extensions (stainless steel)	28
M2 extensions (stainless steel)	28
Star styli (stainless steel)	29
M2 stylus for star styli (stainless steel)	29
Disc styli	29
Disc styli	30
Swivel adaptors	30
5-way styli centre	30
Stylus adaptor (M3-M2/M2-M3)	31
Stylus fixing	31
M2 styli (tungsten carbide)	31
M2 styli	32
M2 pointed styli	32
5-way stylus centre for M2 styli (large)	32
5-way stylus centre for M2 styli (small)	33
M2 joint	33
Custom stylus fax back form	35

Renishaw M5 styli, adaptors and accessories for Zeiss analogue probe systems without probe changing



Part and description (schematic not shown to scale)	Item number	Renishaw part number	Zeiss order number	d (mm)	L (mm)	D (mm)	ML (mm)	ds (mm)	B (mm)	Weight (gr)
<p>Standard probe (tungsten carbide)</p> <p>With cone for direct screw attaching to the measuring probe head</p>	1	A-5555-0001	600331-9096	3	50	19	21.5	2		23
	2	A-5555-0002	602030-9003	3	75	19	35	2		30
	3	A-5555-0003	602030-9004	3	75	19	50	2		22
	4	A-5555-0004	600331-9098	3	115	19	18	2		56
	5	A-5555-0005	602030-9005	5	75	19	35	3.5		34
	6	A-5555-0006	602030-9006	5	75	19	50	3.5		28
	7	A-5555-0007	602030-9007	5	100	19	60	3.5		38
	8	A-5555-0008	600331-9097	8	80	19	57	6		45
	9	A-5555-0009	600331-9099	8	100	19	60	6		57
	10	A-5555-0010	602030-9008	8	115	19	56.5	6		68
	11	A-5555-0011	602030-9009	8	140	19	100	6		74

Part and description (schematic not shown to scale)	Item number	Renishaw part number	Zeiss order number	d (mm)	L (mm)	D (mm)	ML (mm)	ds (mm)	B (mm)	Weight (gr)
<p>Swivel piece with cone</p> <p>By means of a swivel piece, the mounted probes (e.g. star styli) can be adjusted in x/y</p>	1	A-5555-0012	602030-8357		34	18				51

Part and description (schematic not shown to scale)	Item number	Renishaw part number	Zeiss order number	d (mm)	L (mm)	D (mm)	ML (mm)	ds (mm)	B (mm)	Weight (gr)
<p>Adaptor with cone</p> <p>For mounting the probe elements on to the measuring probe head without probe changing</p>	1	A-5555-0013	600331-0001			19				12

Renishaw M5 styli, adaptors and accessories for Zeiss analogue probe systems without probe changing

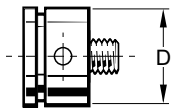
Part and description (schematic not shown to scale)	Item number	Renishaw part number	Zeiss order number	d (mm)	L (mm)	D (mm)	ML (mm)	ds (mm)	B (mm)	Weight (gr)
Adaptor  For mounting of styli with cone onto probe head	1	A-5555-0014	602030-0018			18				12

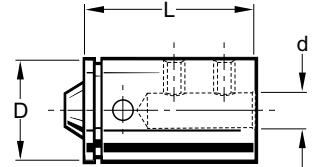
Part and description (schematic not shown to scale)	Item number	Renishaw part number	Zeiss order number	d (mm)	L (mm)	D (mm)	ML (mm)	ds (mm)	B (mm)	Weight (gr)
Holder with cone  Holder for special styli (for measuring probe head only)	1	A-5555-0015	602030-8350	2	24	19				29
	2	A-5555-0016	602030-8351	3.5	24	19				29
	3	A-5555-0017	602030-8352	6	24	19				29

Renishaw M5 styli, adaptors and accessories for Zeiss measuring probe head with probe changer and dynamic probe head (with or without probe changer)



Part and description (schematic not shown to scale)
Standard styli (tungsten carbide)

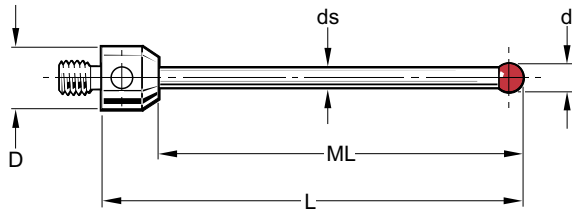

Item number	Renishaw part number	Zeiss order number (*= Drilled ball)	d (mm)	L (mm)	D (mm)	ML (mm)	ds (mm)	B (mm)	Weight (gr)
1	A-5555-0018	602030-9010	3	25	11	15	2		4
2	A-5555-0019	600342-8020	3	33.5	11	23.5	2		4
3	A-5555-0020	602030-9011	3	50	11	40	2		5
4	A-5555-0021	600342-8021	3	58	11	48	2		6
5	A-5555-0022	600342-8025*	4	33.5	11	23.5	2		4
6	A-5555-0023	602030-9012*	4	64	11	54	2		6
7	A-5555-0024	602030-9013	5	50	11	40	3.5		9
8	A-5555-0025	600342-8022	5	53	11	43	3.5		9
9	A-5555-0026	602030-9015	5	75	11	65	3.5		13
10	A-5555-0027	600342-8026	6	54	11	44	3.5		10
11	A-5555-0028	600342-8027	7	55	11	45	3.5		10
12	A-5555-0029	600342-8023	8	63.5	11	50.5	6		25
13	A-5555-0030	600342-8123	8	63.5	19	41.5	6		37
14	A-5555-0031	602030-9014	8	74	11	61	6		30
15	A-5555-0032	602030-9016	8	75	11	62	6		30
16	A-5555-0033	602030-9017	8	100	11	87	6		41
17	A-5555-0034	600342-8024	8	114.5	11	101.5	6		46
18	A-5555-0035	600342-8124	8	114.5	19	92.5	6		59
19	A-5555-0036	600342-8028	9	64.5	11	50.5	6		26
20	A-5555-0037	600342-8128	9	64.5	19	42.5	6		38
21	A-5555-0038	600342-8029	10	65.5	11	52.5	6		27
22	A-5555-0039	600342-8129	10	65.5	19	43.5	6		38
23	A-5555-0040	602030-9018	10	118	11	105	6		47

Part and description (schematic not shown to scale)
Standard styli (ceramic)

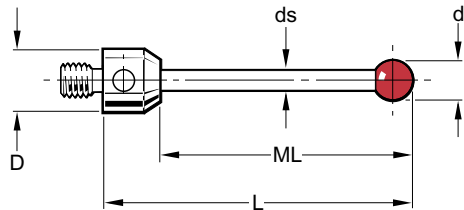

Item number	Renishaw part number	Zeiss order number	d (mm)	L (mm)	D (mm)	ML (mm)	ds (mm)	B (mm)	Weight (gr)
1	A-5555-0041	600342-8013	5	53	11	43	3.5		5
2	A-5555-0042	600342-8016	6	54	11	44	3.5		5
3	A-5555-0043	600342-8017	7	55	11	45	3.5		5
4	A-5555-0044	600342-8014	8	63.5	11	50.5	6		8
5	A-5555-0045	600342-8018	9	64.5	11	51.5	6		9
6	A-5003-0826	600342-8118	9	64.5	19	42.5	6		34
7	A-5555-0047	600342-8019	10	65.5	11	52.5	6		9
8	A-5003-0827	600342-8119	10	65.5	19	43.5	6		33
9	A-5003-0824	600342-8114	8	63.5	19	41.5	6		21
10	A-5555-0050	600342-8015	8	114.5	11	101.5	6		12
11	A-5555-0051	600342-8115	8	114.5	19	92.5	6		38

Renishaw M5 styli, adaptors and accessories for Zeiss measuring probe head with probe changer and dynamic probe head (with or without probe changer)



Part and description (schematic not shown to scale)

Styli (general)

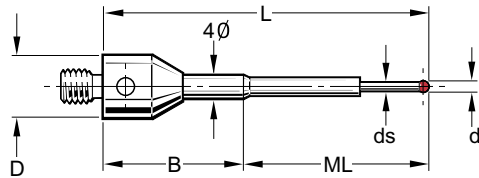

Item number	Renishaw part number	Zeiss order number (*= Drilled ball)	d (mm)	L (mm)	D (mm)	ML (mm)	ds (mm)	B (mm)	Weight (gr)
1	A-5555-0052	602030-8060*	0.8	32	11	12	0.6	20	4
2	A-5555-0053	602030-8061*	1	32	11	12	0.8	20	4
3	A-5555-0054	602030-8062*	1.35	32	11	12	1	20	4
4	A-5555-0055	602030-8063*	1.35	44	11	19	1	25	4
5	A-5555-0056	602030-8064*	1.5	32	11	12	1	20	4
6	A-5555-0057	602030-8065*	1.5	44	11	19	1	25	4
7	A-5555-0058	602030-8066	2	32	11	12	1.5	20	4
8	A-5555-0059	602030-8067	2	44	11	19	1.5	25	5
9	A-5555-0060	602030-8068	2	58	11	33	1.5	25	5
10	A-5555-0061	602030-8069	2.5	32	11	12	1.5	20	4
11	A-5555-0062	602030-8070	2.5	44	11	19	1.5	25	5
12	A-5555-0063	602030-8071	2.5	58	11	33	1.5	25	5

Part and description (schematic not shown to scale)

Fine styli

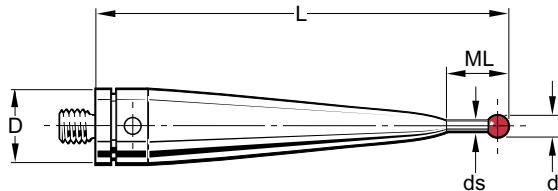

Item number	Renishaw part number	Zeiss order number (*= Drilled ball)	d (mm)	L (mm)	D (mm)	ML (mm)	ds (mm)	B (mm)	Weight (gr)
1	A-5555-0064	602030-9019*	1	55	11	4	0.7		12
2	A-5555-0065	602030-9020*	1.5	55	11	5	1		11
3	A-5555-0066	602030-9021	2	55	11	5	1.5		11
4	A-5555-0067	602030-9022	2.5	55	11	5	2		11
5	A-5555-0068	602030-9023	3.5	55	11	10	2.5		11

Part and description (schematic not shown to scale)

Cube stars

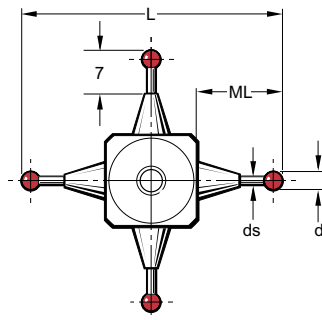

Item number	Renishaw part number	Zeiss order number (*= Drilled ball)	d (mm)	L (mm)	D (mm)	ML (mm)	ds (mm)	B (mm)	Weight (gr)
1	A-5555-0069	602030-9024*	1	45		15	0.7		15
2	A-5555-0070	602030-9025*	1.5	45		15	1.1		15
3	A-5555-0071	602030-9026*	2	45		15	1.5		16
4	A-5555-0072	602030-9027*	2.5	45		15	1.8		16
5	A-5555-0073	602030-9028*	3.5	45		15	2.2		17

Renishaw M5 styli, adaptors and accessories for Zeiss measuring probe head with probe changer and dynamic probe head (with or without probe changer)



Part and description (schematic not shown to scale)

Styli for thread measurement

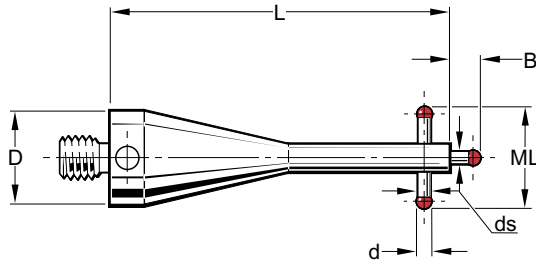

Item number	Renishaw part number	Zeiss order number (*= Drilled ball)	d (mm)	L (mm)	D (mm)	ML (mm)	ds (mm)	B (mm)	Weight (gr)
1	A-5555-0074	602030-9070*	1.35	40	11	9	1.05	2	11
2	A-5555-0075	602030-9071*	2.3	40	11	12	1.84	2.5	13
3	A-5555-0076	602030-9072*	1.8	40	11	10	1.44	2	12
4	A-5555-0077	602030-9073*	0.8	40	11	5	0.6	1.9	7

Part and description (schematic not shown to scale)

Styli for star styli and multi-styli mounting plates (tungsten carbide)

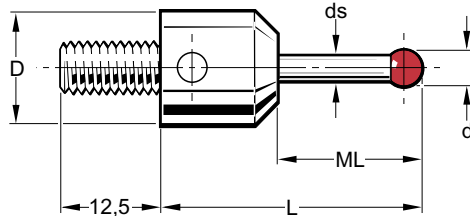

For use with clamping disk only

Item number	Renishaw part number	Zeiss order number (*= Drilled ball)	d (mm)	L (mm)	D (mm)	ML (mm)	ds (mm)	B (mm)	Weight (gr)
1	A-5555-0078	600342-8200*	1.35	32.9	11	23.9	1		6
2	A-5555-0079	600342-8201*	1.5	33	11	24	1		7
3	A-5555-0080	600342-8202	2	33.5	11	24.5	1.5		7
4	A-5555-0081	600342-8203	2.5	34	11	25	1.5		7
5	A-5555-0082	600342-8221	3	34.5	19	16.5	2		20
6	A-5555-0083	600342-8222	5	43.5	19	25.5	3.5		23

Length of thread 5 mm (instead of 12.5 mm) is also available

Part and description (schematic not shown to scale)

Styli for star styli and multi-styli mounting plates (tungsten carbide)

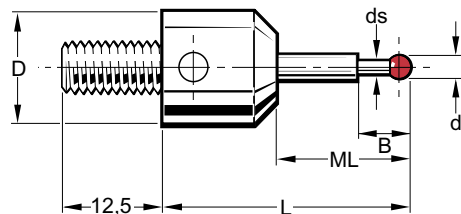

For use with clamping disk only

Item number	Renishaw part number	Zeiss order number (*= Drilled ball)	d (mm)	L (mm)	D (mm)	ML (mm)	ds (mm)	B (mm)	Weight (gr)
1	A-5555-0084	600342-8250	0.3	21.8	11	12.8	0.2	2.3	6
2	A-5555-0085	600342-8251	0.5	22	11	13	0.3	2.5	6
3	A-5555-0086	600342-8252	0.6	22.1	11	13.1	0.4	4.6	6
4	A-5555-0087	600342-8253*	0.8	22.3	11	13.3	0.6	4.8	6
5	A-5555-0088	600342-8254*	1	22.5	11	13.5	0.8	5	6

Length of thread 5 mm (instead of 12.5 mm) is also available

Renishaw M5 styli, adaptors and accessories for Zeiss measuring probe head with probe changer and dynamic probe head (with or without probe changer)

Part and description (schematic not shown to scale)	Item number	Renishaw part number	Zeiss order number	d (mm)	L (mm)	D (mm)	ML (mm)	ds (mm)	B (mm)	Weight (gr)
Clamping disk for star styli	1	A-5555-0089	600341-0140			11			1.5	1
	2	A-5555-0090	600341-0141			19			2	4

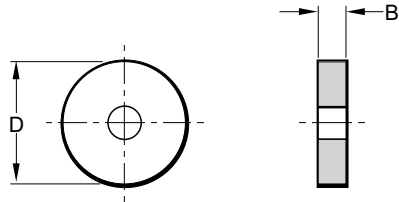

Part and description (schematic not shown to scale)	Item number	Renishaw part number	Zeiss order number	d (mm)	L (mm)	D (mm)	ML (mm)	ds (mm)	B (mm)	Weight (gr)
Slot disk for star styli	1	A-5555-0091	600341-0150	1/1.5		11			2	1
	2	A-5555-0092	600341-0151	2/3.5		19			4	7

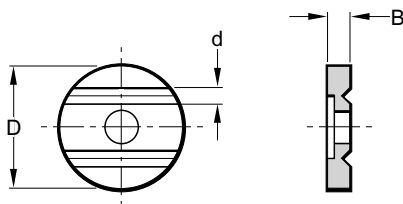

Part and description (schematic not shown to scale)	Item number	Renishaw part number	Zeiss order number	d (mm)	L (mm)	D (mm)	ML (mm)	ds (mm)	B (mm)	Weight (gr)
Tungsten carbide pin for star styli	1	A-5555-0093	600341-0520		10	1				1
	2	A-5555-0094	600341-0521		10	1.5				1
	3	A-5555-0095	600341-0522		18	2				1
	4	A-5555-0096	600341-0523		18	3.5				3

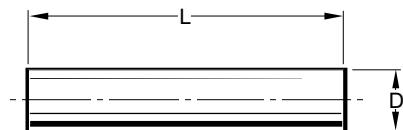

Renishaw M5 styli, adaptors and accessories for Zeiss measuring probe head with probe changer and dynamic probe head (with or without probe changer)

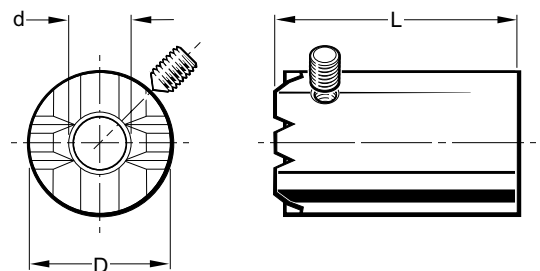
Part and description (schematic not shown to scale)	Item number	Renishaw part number	Zeiss order number	d (mm)	L (mm)	D (mm)	ML (mm)	ds (mm)	B (mm)	Weight (gr)
Mounting support for star styli 	1	A-5555-0097	600341-8300	11	50	35				130
	2	A-5555-0098	600341-8301	19	85	45				317

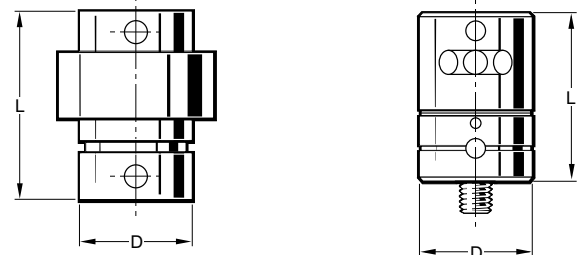
Part and description (schematic not shown to scale)	Item number	Renishaw part number	Zeiss order number	d (mm)	L (mm)	D (mm)	ML (mm)	ds (mm)	B (mm)	Weight (gr)
Rotational adjustment piece 	1	A-5555-0099	602030-9095		30	18				43
	2	A-5555-0100	600341-8356		25	18				26
	3	A-5555-0101	602030-8358		25	11				11
	4	A-5555-0102			23	11				12
	5	A-5555-0103			27	18/11				35

Part and description (schematic not shown to scale)	Item number	Renishaw part number	Zeiss order number	d (mm)	L (mm)	D (mm)	ML (mm)	ds (mm)	B (mm)	Weight (gr)
Holder for styli (d = 1....1.5 mm) 	1	A-5555-0104	600341-8160	1/1.5	45	11			27.5	16

Renishaw M5 styli, adaptors and accessories for Zeiss measuring probe head with probe changer and dynamic probe head (with or without probe changer)

Part and description (schematic not shown to scale)	Item number	Renishaw part number	Zeiss order number	d (mm)	L (mm)	D (mm)	ML (mm)	ds (mm)	B (mm)	Weight (gr)
Holder for 5 styli (maximum)	1	A-5555-0105	600341-8367	1	10	11				3
	2	A-5555-0106	600341-8368	1.5	10	11				3

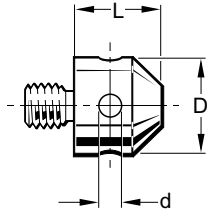

Part and description (schematic not shown to scale)	Item number	Renishaw part number	Zeiss order number (* = Drilled ball)	d (mm)	L (mm)	D (mm)	ML (mm)	ds (mm)	B (mm)	Weight (gr)
Styli (for universal 3D probe head only) (tungsten carbide)	1	A-5555-0107	600341-8454*	1	16	1	5	0.8		1
	2	A-5555-0108	600341-8450	0.3	15.3	1	2.3	0.2		1
	3	A-5555-0109	600341-8451	0.5	15.5	1	2.5	0.3		1
	4	A-5555-0110	600341-8452	0.6	15.6	1	4.6	0.4		1
	5	A-5555-0111	600341-8453*	0.8	15.8	1	4.8	0.6		1

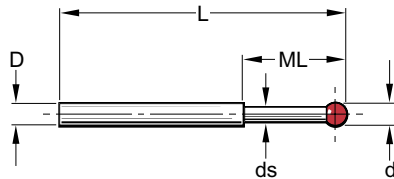

Part and description (schematic not shown to scale)	Item number	Renishaw part number	Zeiss order number (* = Drilled ball)	d (mm)	L (mm)	D (mm)	ML (mm)	ds (mm)	B (mm)	Weight (gr)
Styli (tungsten carbide)	1	A-5555-0112	600341-8500*	1.35	26.4	1				1
	2	A-5555-0113	600341-8501*	1.5	26.5	1				1
	3	A-5555-0114	600341-8502	2	27	1.5				1
	4	A-5555-0115	600341-8503	2.5	27.5	1.5				1
	5	A-5555-0116	600341-8510	3	38	2				2
	6	A-5555-0117	600341-8511	5	45	3.5				6

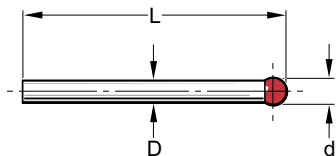

Renishaw M5 styli, adaptors and accessories for Zeiss measuring probe head with probe changer and dynamic probe head (with or without probe changer)

Part and description (schematic not shown to scale)	Item number	Renishaw part number	Zeiss order number	d (mm)	L (mm)	D (mm)	ML (mm)	ds (mm)	B (mm)	Weight (gr)
Holder for swivel styli	1	A-5555-0118	600341-8180		40	11			22	15

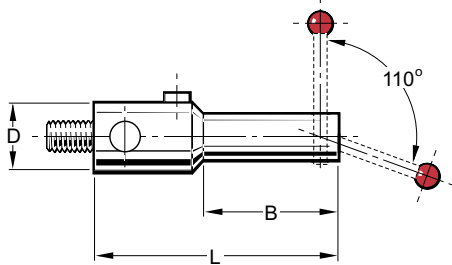

Part and description (schematic not shown to scale)	Item number	Renishaw part number	Zeiss order number (* = Drilled ball)	d (mm)	L (mm)	D (mm)	ML (mm)	ds (mm)	B (mm)	Weight (gr)
Swivel styli (tungsten carbide)	1	A-5555-0119	600341-8183*	1	17.5	1	5	0.8		1
	2	A-5555-0120	600341-8185	2	28.5	1.5	22	1.5		1

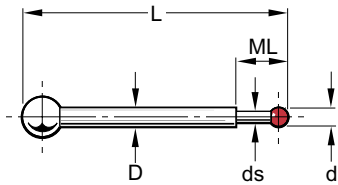

Part and description (schematic not shown to scale)	Item number	Renishaw part number	Zeiss order number	d (mm)	L (mm)	D (mm)	ML (mm)	ds (mm)	B (mm)	Weight (gr)
Spherical disc styli										
steel	1	A-5555-0121	600341-8090	10	21.5	7			1.5	3
steel	2	A-5555-0122	600341-8095	15	21.5	10			1.5	6
ceramic	3	A-5555-0123	602030-8091	20	60	7			1	8
ceramic	4	A-5555-0124	602030-8092	15	40	7			1	5

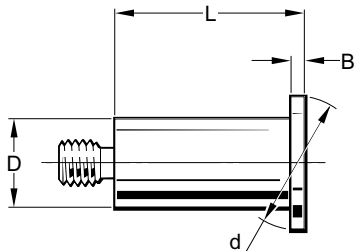

Renishaw M5 styli, adaptors and accessories for Zeiss measuring probe head with probe changer and dynamic probe head (with or without probe changer)



Part and description (schematic not shown to scale)

Extensions (aluminium)



Item number	Renishaw part number	Zeiss order number	d (mm)	L (mm)	D (mm)	ML (mm)	ds (mm)	B (mm)	Weight (gr)
1	A-5555-0125	600341-8420		200	20				85
2	A-5555-0126	600341-8421		150	20				68
3	A-5555-0127	600341-8422		100	20				50
4	A-5555-0128	600341-8423		80	20				43
5	A-5555-0129	600341-8424		60	20				37
6	A-5555-0130	600341-8425		40	20				32
7	A-5555-0131	600341-8265		120	11				30
8	A-5555-0132	600341-8264		100	11				24
9	A-5555-0133	600341-8263		80	11				19
10	A-5555-0134	600341-8262		60	11				14
11	A-5555-0135	600341-8261		40	11				10

Part and description (schematic not shown to scale)

Extensions (stainless steel)

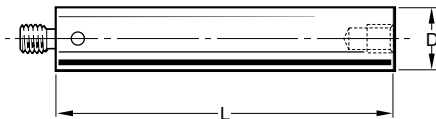

Item number	Renishaw part number	Zeiss order number	d (mm)	L (mm)	D (mm)	ML (mm)	ds (mm)	B (mm)	Weight (gr)
1	A-5555-0136	600341-0260		100	11				73
2	A-5555-0137	600341-0258		80	11				58
3	A-5555-0138	600341-0256		60	11				42
4	A-5555-0139	600341-0254		40	11				28
5	A-5555-0140	600341-0252		20	11				13
6	A-5555-0141	600341-0251		15	11				9
7	A-5555-0142	600341-0250		10	11				6

Renishaw M5 styli, adaptors and accessories for Zeiss measuring probe head with probe changer and dynamic probe head (with or without probe changer)

**Part and description
(schematic not shown to scale)**

Extensions (titanium)



Item number	Renishaw part number	Zeiss order number	d (mm)	L (mm)	D (mm)	ML (mm)	ds (mm)	B (mm)	Weight (gr)
1	A-5555-0143	602030-9044		10	11				4
2	A-5555-0144	602030-9045		15	11				6
3	A-5555-0145	602030-9046		20	11				7
4	A-5555-0146	602030-9047		25	11				9
5	A-5555-0147	602030-9048		25	18				26
6	A-5555-0148	602030-9049		40	11				14
7	A-5555-0149	602030-9050		40	18				43
8	A-5555-0150	602030-9051		50	11				15
9	A-5555-0151	602030-9052		50	18				35
10	A-5555-0152	602030-9053		60	11				16
11	A-5555-0153	602030-9054		60	18				38
12	A-5555-0154	602030-9055		75	11				19
13	A-5555-0155	602030-9056		75	18				42
14	A-5555-0156	602030-9057		80	11				19
15	A-5555-0157	602030-9058		80	18				41
16	A-5555-0158	602030-9059		90	11				20
17	A-5555-0159	602030-9060		90	18				47
18	A-5555-0160	602030-9061		100	11				22
19	A-5555-0161	602030-9062		100	18				50
20	A-5555-0162	602030-9063		120	11				25
21	A-5555-0163	602030-9064		120	18				56
22	A-5555-0164	602030-9065		150	11				29
23	A-5555-0165	602030-9066		150	18				68
24	A-5555-0166	602030-9067		200	18				81
25	A-5555-0167	602030-9068		250	18				102
26	A-5555-0168	602030-9069		300	18				114

Renishaw M5 styli, adaptors and accessories for Zeiss measuring probe head with probe changer and dynamic probe head (with or without probe changer)



Part and description (schematic not shown to scale)		Item number	Renishaw part number	Zeiss order number	d (mm)	L (mm)	D (mm)	ML (mm)	ds (mm)	B (mm)	Weight (gr)
Extensions (carbon fibre)		1	A-5555-0169	602030-0263		40	11				8
		2	A-5555-0170	602030-0264		50	11				9
		3	A-5555-0171	602030-0262		60	11				9
		4	A-5555-0172	602030-0265		75	11				10
		5	A-5555-0173	602030-0261		80	11				11
		6	A-5555-0174	602030-0266		90	11				11
		7	A-5555-0175	602030-0267		100	11				12
		8	A-5555-0176	602030-0259		120	11				13
		9	A-5555-0177	602030-0268		150	11				15
		10	A-5555-0178	602030-0270		160	11				16
		11	A-5555-0179	602030-0275		200	11				18
		12	A-5555-0180	602030-0271		210	11				19
		13	A-5555-0181	602030-0295		40	21				39
		14	A-5555-0182	602030-0294		60	21				42
		15	A-5555-0183	602030-0293		80	21				45
		16	A-5555-0184	602030-0292		100	21				48
		17	A-5555-0185	602030-0291		150	21				55
		18	A-5555-0186	602030-0290		200	21				62
		19	A-5555-0187	602030-0274		250	21				69
		20	A-5555-0188	602030-0269		300	21				77



Part and description (schematic not shown to scale)		Item number	Renishaw part number	Zeiss order number	d (mm)	L (mm)	D (mm)	ML (mm)	ds (mm)	B (mm)	Weight (gr)
Cubes											
	titanium	1	A-5555-0189	600341-8361						15	13
	titanium	2	A-5555-0190	600341-8002						20	32
	aluminium	3	A-5555-0191	602030-8363						15	7.5
	aluminium	4	A-5555-0192	602030-8362						20	20
	titanium	5	A-5555-0193							25	25

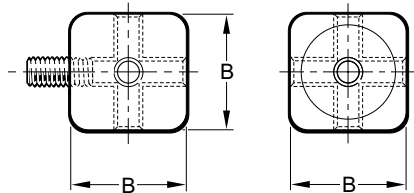

Renishaw M5 styli, adaptors and accessories for Zeiss measuring probe head with probe changer and dynamic probe head (with or without probe changer)

Part and description (schematic not shown to scale)	Item number	Renishaw part number	Zeiss order number	d (mm)	L (mm)	D (mm)	ML (mm)	ds (mm)	B (mm)	Weight (gr)
Double cube (titanium)	1	A-5555-0194	600342-8103		40				20	64

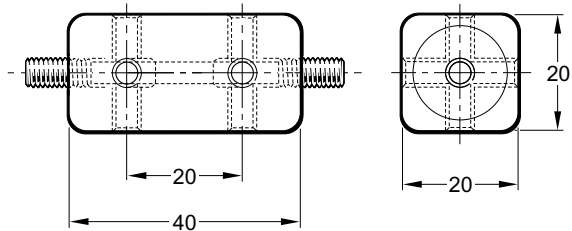

Part and description (schematic not shown to scale)	Item number	Renishaw part number	Zeiss order number	d (mm)	L (mm)	D (mm)	ML (mm)	ds (mm)	B (mm)	Weight (gr)
Stylus discs (hardened steel)	1	A-5555-0195	602030-0003	4		10			M5	2
	2	A-5555-0196	602030-0004	4		15			M5	5
	3	A-5555-0197	602030-0005	4		20			M5	9
	4	A-5555-0198	602030-0006	4		30			M5	21
	5	A-5555-0199	602030-0007	5		40			M5	42
	6	A-5555-0200	602030-0008	5		50			M5	64
	7	A-5555-0201	602030-0009	5		60			M5	89
	8	A-5555-0202	602030-0010	3		15			8	4
	9	A-5555-0203	602030-0011	4		20			8	8
	10	A-5555-0204	600341-0200	2		20			8	4
	11	A-5555-0205	600341-0203	3		30			8	10
	12	A-5555-0206	600341-0204	4		40			8	21
	13	A-5555-0207	600341-0205	5		50			8	36
	14	A-5555-0208	600341-0206	6		60			8	59

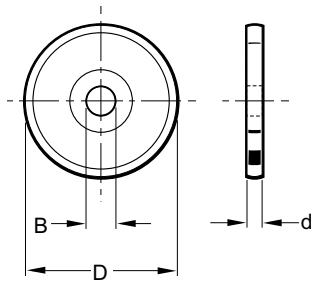

Renishaw M5 styli, adaptors and accessories for Zeiss measuring probe head with probe changer and dynamic probe head (with or without probe changer)



Part and description (schematic not shown to scale)

Thread styli (steel)

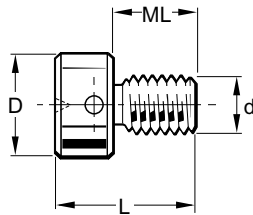

Item number	Renishaw part number	Zeiss order number	d (mm)	L (mm)	D (mm)	ML (mm)	ds (mm)	B (mm)	Weight (gr)
1	A-5555-0209	602030-0012	M4	16	10	10			4
2	A-5555-0210	602030-0013	M5	16	10	10			4
3	A-5555-0211	602030-0014	M6	18	12	12			7
4	A-5555-0212	602030-0015	M8	20	15	12			13
5	A-5555-0213	602030-0016	M10	25	18	15			25
6	A-5555-0214	602030-0017	M12	25	20	15			33

Part and description (schematic not shown to scale)

Star stylus

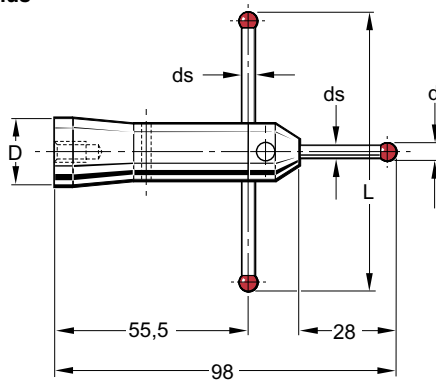

Item number	Renishaw part number	Zeiss order number	d (mm)	L (mm)	D (mm)	ML (mm)	ds (mm)	B (mm)	Weight (gr)
1	A-5555-0215	600331-8093	5	80	19		3.5		62

Part and description (schematic not shown to scale)

Pointed stylus

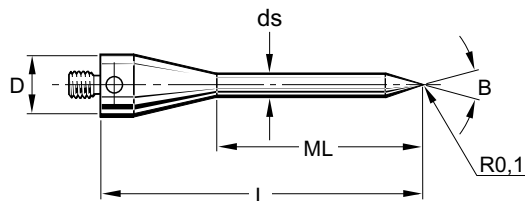

Item number	Renishaw part number	Zeiss order number	d (mm)	L (mm)	D (mm)	ML (mm)	ds (mm)	B (deg)	Weight (gr)
1	A-5555-0216	600342-8051		61	11	39	3.5	30°	12

Renishaw M5 styli, adaptors and accessories for Zeiss measuring probe head with probe changer and dynamic probe head (with or without probe changer)

Part and description (schematic not shown to scale)	Item number	Renishaw part number	Zeiss order number	d (mm)	L (mm)	D (mm)	ML (mm)	ds (mm)	B (mm)	Weight (gr)
Cube extension	1	A-5555-0217	602030-0019		120				20	87

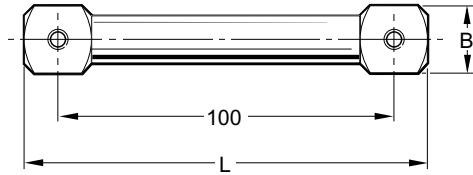

Part and description (schematic not shown to scale)	Item number	Renishaw part number	Zeiss order number	d (mm)	L (mm)	D (mm)	ML (mm)	ds (mm)	B (mm)	Weight (gr)
Joint (titanium)	1	A-5555-0218	600342-9002		30	11				11
	2	A-5555-0219	600342-9003		36	18				37

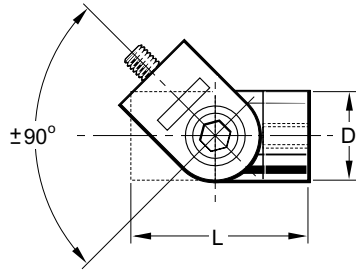

Part and description (schematic not shown to scale)	Item number	Renishaw part number	Zeiss order number	d (mm)	L (mm)	D (mm)	ML (mm)	ds (mm)	B (mm)	Weight (gr)
Multi-styli mounting plate (for Zeiss MT and VAST probe heads only)	1	A-5555-0220	600342-8060							357

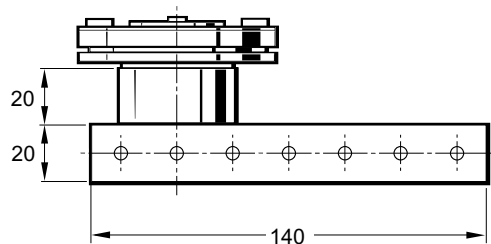

Renishaw M5 styli, adaptors and accessories for Zeiss measuring probe head with probe changer and dynamic probe head (with or without probe changer)

**Part and description
(schematic not shown to scale)**

Bolts for spherical disk and cube (stainless steel)

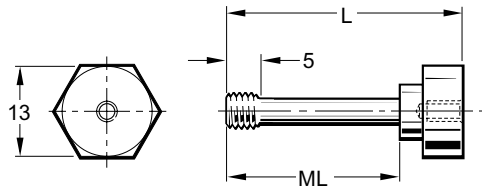

Item number	Renishaw part number	Zeiss order number	d (mm)	L (mm)	D (mm)	ML (mm)	ds (mm)	B (mm)	Weight (gr)
1	A-5555-0221	600341-0210		35		26			9
2	A-5555-0222	600341-0211		30		21			9
3	A-5555-0223	600341-0212		17.3		10			7

**Part and description
(schematic not shown to scale)**

Bolts for cubes (stainless steel)

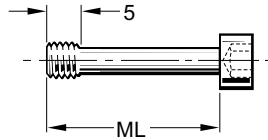

Item number	Renishaw part number	Zeiss order number	d (mm)	L (mm)	D (mm)	ML (mm)	ds (mm)	B (mm)	Weight (gr)
1	A-5555-0224	600341-0220				26			4
2	A-5555-0225	600341-0221				21			3

Renishaw adaptors for the assembly of M2, M3 and M5 styli to Zeiss measuring probe heads

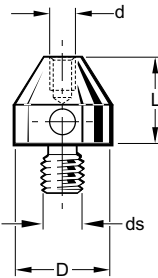
Part and description (schematic not shown to scale)	Item number	Renishaw part number	Zeiss order number	d (mm)	L (mm)	D (mm)	ML (mm)	ds (mm)	B (mm)	Weight (gr)
Adaptor 	1	A-5555-0226	602030-0215	M2	10	11		M5		5
	2	A-5555-0227	602030-0315	M3	10	11		M5		5
	3	A-5555-0228	602030-0318	M4	10	11		M5		5
	4	A-5555-0229	602030-0316	M2	10	11		M4		5
	5	A-5555-0230	602030-0317	M3	10	11		M4		5

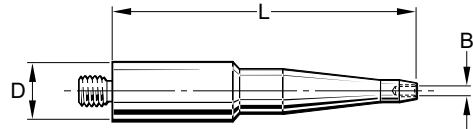
Part and description (schematic not shown to scale)	Item number	Renishaw part number	Zeiss order number	d (mm)	L (mm)	D (mm)	ML (mm)	ds (mm)	B (mm)	Weight (gr)
Digitizer adaptor 	1	A-5555-0231	602030-9113		119	15.81			M2	126
	2	A-5555-0232	602030-9115		127	9.52			M2	87

Renishaw tools and accessories for the assembly of M2, M3 and M5 styli to Zeiss measuring probe heads

Part and description	Item number	Renishaw part number	Zeiss order number	d (mm)	L (mm)	D (mm)	ML (mm)	ds (mm)	B (mm)	Weight (gr)
Stylus tool (M2 and M3 styli)	1	A-5555-0233	602030-0001	1.2	23					1
										

Part and description	Item number	Renishaw part number	Zeiss order number	d (mm)	L (mm)	D (mm)	ML (mm)	ds (mm)	B (mm)	Weight (gr)
Allen keys DIN 911	1	A-5555-0234	602030-0002						SW1.5	1
	2	A-5555-0235	602030-0042						SW0.9	1
	3	A-5555-0236	602030-0021						SW2.5	2

Part and description	Item number	Renishaw part number	Zeiss order number	d (mm)	L (mm)	D (mm)	ML (mm)	ds (mm)	B (mm)	Weight (gr)
Toolkit, consisting of:	1	A-5555-0237	600341-8595							
1 x offset screwdriver DIN 911-2		A-5555-0328							SW2	1
1 x offset screwdriver DIN 911-3		A-5555-0327							SW3	5
1 x offset screwdriver DIN 911-4		A-5555-0326							SW4	10
2 x pin-type spanner 2.9		A-5555-0333		2.9	70	5				15 each
1 x single-headed spanner DIN 894		A-5555-0325							SW13	39

Part and description	Item number	Renishaw part number	Zeiss order number	d (mm)	L (mm)	D (mm)	ML (mm)	ds (mm)	B (mm)	Weight (gr)
Stylus tool kit, consisting of two pin-type 2.9	1	A-5555-0238	600341-8596	2.9	70	5				15

Part and description	Item number	Renishaw part number	Zeiss order number	d (mm)	L (mm)	D (mm)	ML (mm)	ds (mm)	B (mm)	Weight (gr)
Stylus tool 1.7 for M5	1	A-5555-0239	602030-0027	1.7	49	2.5				1

Part and description	Item number	Renishaw part number	Zeiss order number	d (mm)	L (mm)	D (mm)	ML (mm)	ds (mm)	B (mm)	Weight (gr)
Pin-type spanner 2.9 for M5	1	A-5555-0240	602030-0222	2.9	70	5				7.5

Renishaw tools and accessories for the assembly of M2, M3 and M5 styli to Zeiss measuring probe heads



Part and description	Item number	Renishaw part number	Zeiss order number	d (mm)	L (mm)	D (mm)	ML (mm)	ds (mm)	B (mm)	Weight (gr)
Assortment of screws, comprising:	1	A-5555-0241	600341-8590							27
10 x spring washer FS 5x7										
2 x cheese-head screw M5x12					12					
2 x cheese-head screw M5x20					20					
4 x grub screw, L = 10					10					
2 x grub screw, L = 25					25					

Part and description	Item number	Renishaw part number	Zeiss order number	d (mm)	L (mm)	D (mm)	ML (mm)	ds (mm)	B (mm)	Weight (gr)
Spring-lock washers, consisting of 10 x FS 5.7 spring-lock washers	1	A-5555-0242	600341-0042							

Part and description	Item number	Renishaw part number	Zeiss order number	d (mm)	L (mm)	D (mm)	ML (mm)	ds (mm)	B (mm)	Weight (gr)
C spanners DIN 1810	1	A-5555-0243	602030-0044	11						
	2	A-5555-0244	602030-0045	21						

Renishaw adaptor plates for Zeiss probe heads



**Part and description
(schematic not shown to scale)**

M-SYS adaptor plates:

- 2 x adaptor plate
- 10 x adaptor plate
- 2 x adaptor plate (special coded)
- 10 x adaptor plate (special coded)

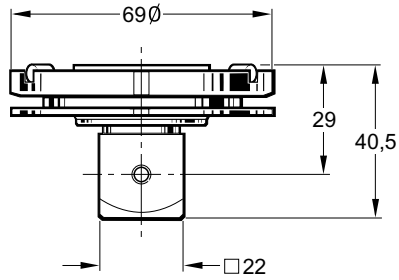

Item number	Renishaw part number	Zeiss order number	d (mm)	L (mm)	D (mm)	ML (mm)	ds (mm)	B (mm)	Weight (gr)
1	A-5555-0245	600665-8573							181 each
2	A-5555-0246	600665-8572							181 each
3	A-5555-0247	600665-8583							179 each
4	A-5555-0248	600665-8582							179 each

**Part and description
(schematic not shown to scale)**

Adaptor plate (with disc and roller, but without cube)

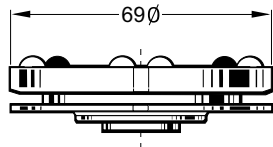

Item number	Renishaw part number	Zeiss order number	d (mm)	L (mm)	D (mm)	ML (mm)	ds (mm)	B (mm)	Weight (gr)
1	A-5555-0249	600665-9112							166

Renishaw adaptor plates for Zeiss probe heads



Part and description (schematic not shown to scale)	Item number	Renishaw part number	Zeiss order number	d (mm)	L (mm)	D (mm)	ML (mm)	ds (mm)	B (mm)	Weight (gr)
Adaptor plate (titanium)	1	A-5555-0250	600665-9116							117

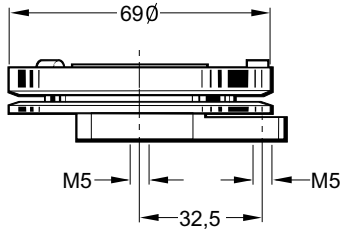

Part and description (schematic not shown to scale)	Item number	Renishaw part number	Zeiss order number	d (mm)	L (mm)	D (mm)	ML (mm)	ds (mm)	B (mm)	Weight (gr)
Adaptor plates (S-SYS):										
1 x adaptor plate	1	A-5555-0322	600660-8240							72 each
2 x adaptor plate	2	A-5555-0251	600660-8251							72 each
10 x adaptor plate	3	A-5555-0252	600660-8250							72 each

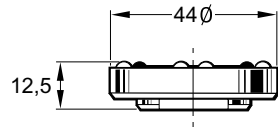

Renishaw adaptor plates Zeiss probe heads



Part and description (schematic not shown to scale)	Item number	Renishaw part number	Zeiss order number	d (mm)	L (mm)	D (mm)	ML (mm)	ds (mm)	B (mm)	Weight (gr)
Adaptor plates (Prismo):										
2 x adaptor plate	1	A-5555-0253	620660-8251							67 each
10 x adaptor plate	2	A-5555-0254	620660-8250							67 each

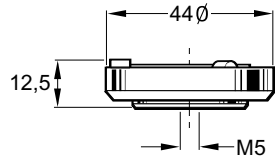

Part and description (schematic not shown to scale)	Item number	Renishaw part number	Zeiss order number	d (mm)	L (mm)	D (mm)	ML (mm)	ds (mm)	B (mm)	Weight (gr)
Adaptor plates (Prismo VAST)										
1 x adaptor plate	1	A-5555-0255	600667-8570							158 each
2 x adaptor plate	2	A-5555-0256	600667-8573							158 each
10 x adaptor plate	3	A-5555-0257	600667-8572							158 each

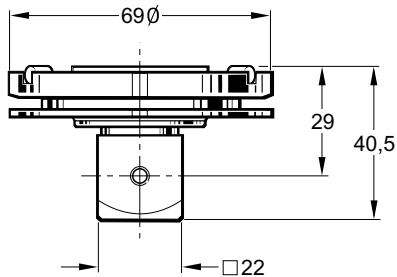

Renishaw adaptor plates for Zeiss probe heads



Part and description (schematic not shown to scale)	Item number	Renishaw part number	Zeiss order number	d (mm)	L (mm)	D (mm)	ML (mm)	ds (mm)	B (mm)	Weight (gr)
Adaptor plate (Prismo VAST):										
1 x adaptor plate	1	A-5555-0258	600667-8571							130 each
2 x adaptor plate	2	A-5555-0259	600667-8574							130 each
10 x adaptor plate	3	A-5555-0260	600667-8575							130 each

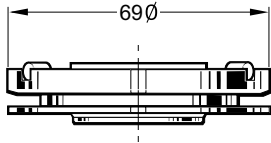

Renishaw adaptor elements for Zeiss RST probe systems with M2/M3 connecting thread



Part and description (schematic not shown to scale)

M3 styli

TC = tungsten carbide

C = ceramic

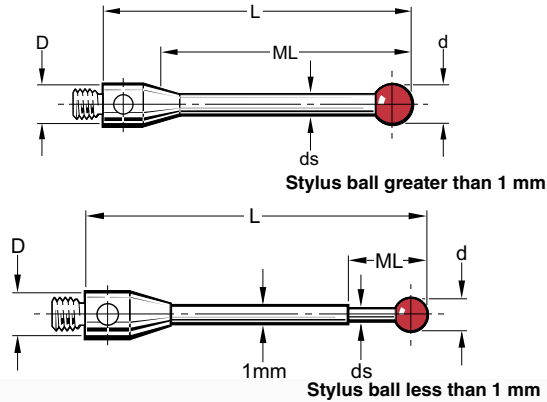

Item number	Renishaw part number	Zeiss order number (*= Drilled ball)	d (mm)	L (mm)	D (mm)	ML (mm)	ds (mm)	Material	Weight (gr)
1	A-5555-0261	602030-8104*	2	22	4	9	1	TC	1
2	A-5555-0262	602030-8103	3	40	5.5	21.5	2	TC	4
3	A-5555-0263	602030-8113*	3	40	5.5	21.5	2	TC	4
4	A-5555-0264	602030-8102*	4	32	4	26	2	C	1
5	A-5555-0265	602030-8112	4	32	4	26	2	TC	1
6	A-5555-0266	602030-8101*	5	32	4	19	2	C	1
7	A-5555-0267	602030-8115	0.5	22	4	9	0.3	TC	1
8	A-5555-0268	602030-8116	0.6	22	4	9	0.4	TC	1
9	A-5555-0269	602030-8117*	0.8	22	4	9	0.6	TC	1
10	A-5555-0270	602030-8118	1	22	4	9	0.8	TC	1
11	A-5555-0271	602030-8119	1.5	22	4	9	1	TC	1
12	A-5555-0272	602030-8120	1	10.5	4	5.5	0.8	TC	1
13	A-5555-0273	602030-8121	0.3	22	4	9	0.2	TC	1
14	A-5555-0274	602030-8023*	2	21	4	15	1	TC	1
15	A-5555-0275	602030-8020*	6	13	4	9	2	C	1
16	A-5555-0276	603020-8021*	3	21.5	4	15.5	1.5	TC	1
17	A-5555-0277	602030-8106	3	21	4	13	2	TC	1

Part and description (schematic not shown to scale)

M2 styli

TC = tungsten carbide

C = ceramic

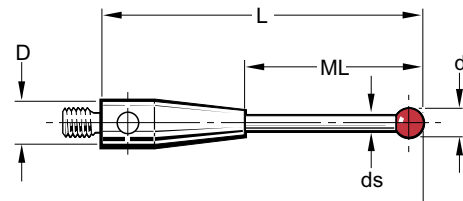

Item number	Renishaw part number	Zeiss order number (*= Drilled ball)	d (mm)	L (mm)	D (mm)	ML (mm)	ds (mm)	Material	Weight (gr)
1	A-5555-0278	602030-8002*	6	13	3	9	2	C	1
2	A-5555-0279	602030-8004*	5	22.5	3	16.5	2	C	1
3	A-5003-0938	602030-8003*	3	21.5	3	15.5	1.5	TC	1
4	A-5003-3822	602030-8005*	2	21	3	15	1	TC	1
5	A-5555-0282	602030-8001*	2	11	3	5	1	TC	1
6	A-5555-0283	602030-8034*	5	22.5	3	16.5	2	TC	1

Renishaw adaptor elements for Zeiss RST probe systems with M2/M3 connecting thread

Part and description (schematic not shown to scale)	Item number	Renishaw part number	Zeiss order number	d (mm)	L (mm)	D (mm)	ML (mm)	ds (mm)	B (mm)	Weight (gr)
M3 extensions (stainless steel)	1	M-5000-7633	602030-8301		10	4				1
	2	M-5000-3592	602030-8302		20	4				1
	3	A-5555-0286	602030-8303		30	4				2
	4	A-5555-0287	602030-8304		40	4				3
	5	A-5555-0288	602030-8305		50	4				4

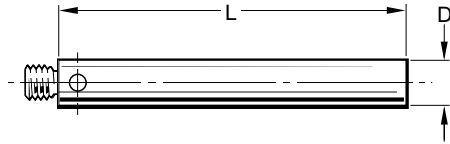

Part and description (schematic not shown to scale)	Item number	Renishaw part number	Zeiss order number	d (mm)	L (mm)	D (mm)	ML (mm)	ds (mm)	B (mm)	Weight (gr)
M2 extensions (stainless steel)	1	M-5000-7634	602030-8321		5	3				1
	2	M-5000-3647	602030-8322		10	3				1
	3	M-5000-3648	602030-8323		20	3				1
	4	M-5000-4162	602030-8324		30	3				1
	5	M-5000-7779	602030-8325		40	3				2

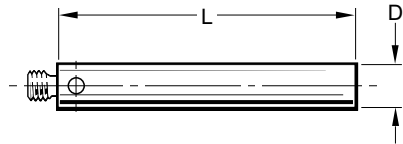

Renishaw adaptor elements for Zeiss RST probe systems with M2/M3 connecting thread

Part and description (schematic not shown to scale)	Item number	Renishaw part number	Zeiss order number	d (mm)	L (mm)	D (mm)	ML (mm)	ds (mm)	B (mm)	Weight (gr)
Star styli (stainless steel)	1	A-5555-0294	602030-8011	2	32		13.2	1.4	2H7	1
	2	A-5555-0295	602030-8010	2	22		8.2	1.4	2H7	1

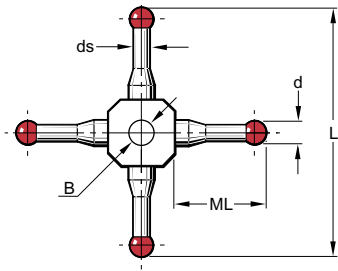

Part and description (schematic not shown to scale)	Item number	Renishaw part number	Zeiss order number	d (mm)	L (mm)	D (mm)	ML (mm)	ds (mm)	B (mm)	Weight (gr)
M2 stylus for star styli (stainless steel)	1	A-5555-0296	602030-8012	2	19.5	3	13.5	1.5		1

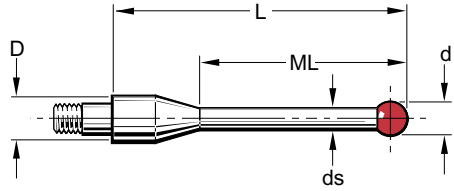

Part and description (schematic not shown to scale)	Item number	Renishaw part number	Zeiss order number	d (mm)	L (mm)	D (mm)	ML (mm)	ds (mm)	B (mm)	Weight (gr)
Disc styli	1	A-5555-0297	602030-8201	8	32	3	19	1.5	1.5	1
	2	A-5555-0298	602030-8202	4	32	3	19	1	1	1

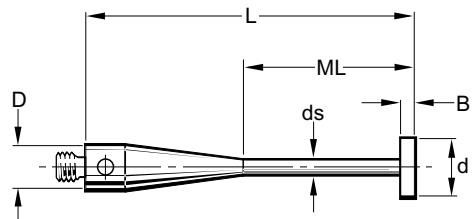

Renishaw adaptor elements for Zeiss RST probe systems with M2/M3 connecting thread

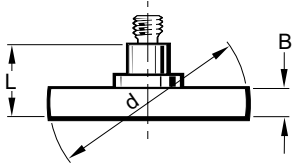
Part and description (schematic not shown to scale)	Item number	Renishaw part number	Zeiss order number	d (mm)	L (mm)	D (mm)	ML (mm)	ds (mm)	B (mm)	Weight (gr)
Disc styli	1	A-5555-0299	602030-8203	14	5				2	1
	2	A-5555-0300	602030-8204	20	5				2.5	3
										

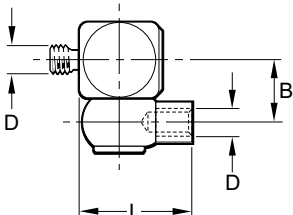
Part and description (schematic not shown to scale)	Item number	Renishaw part number	Zeiss order number	d (mm)	L (mm)	D (mm)	ML (mm)	ds (mm)	B (mm)	Weight (gr)
Swivel adaptors	1	A-5000-7616	602030-9102		12	M3			6	3
	2	A-5000-7534	602030-9101		8	M2			4.5	1
										

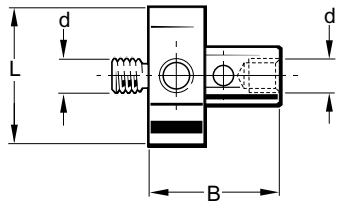
Part and description (schematic not shown to scale)	Item number	Renishaw part number	Zeiss order number	d (mm)	L (mm)	D (mm)	ML (mm)	ds (mm)	B (mm)	Weight (gr)
5-way styli centre	1	A-5555-0303	602030-8382	M3	12				11.5	4
	2	A-5000-3627	602030-8381	M2	7				8	1
										

Renishaw adaptor elements for Zeiss RST probe systems with M2/M3 connecting thread

Part and description (schematic not shown to scale)	Item number	Renishaw part number	Zeiss order number	d (mm)	L (mm)	D (mm)	ML (mm)	ds (mm)	B (mm)	Weight (gr)
Stylus adaptor (M3-M2/M2-M3)	1	M-5000-4163	602030-8341		5	M2		M3		1
	2	A-5555-0306	602030-8345		5	M3		M2		1

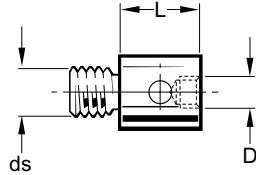

Part and description (schematic not shown to scale)	Item number	Renishaw part number	Zeiss order number	d (mm)	L (mm)	D (mm)	ML (mm)	ds (mm)	B (mm)	Weight (gr)
Stylus fixing	1	A-5555-0307	600661-8195							14

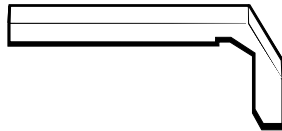

Part and description (schematic not shown to scale)	Item number	Renishaw part number	Zeiss order number (* = Drilled ball)	d (mm)	L (mm)	D (mm)	ML (mm)	ds (mm)	B (mm)	Weight (gr)
M2 styli (tungsten carbide)	1	A-5555-0308	602030-8006*	1	10.5	3	6.5	0.8		1
	2	A-5555-0309	602030-8007*	1	15.5	3	11.5	0.8		1
	3	A-5555-0310	602030-8008*	2	11	3	7	1		1
	4	A-5555-0311	602030-8009*	2	16	3	12	1		1
	5	A-5555-0312	602030-8015*	4	12	3	8	2.4		1
	6	A-5555-0313	602030-8016*	4	22	3	18	2.4		1

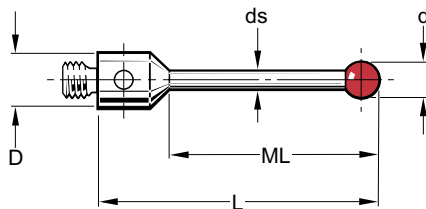

Renishaw adaptor elements for Zeiss RST probe systems with M2/M3 connecting thread

Part and description (schematic not shown to scale)	Item number	Renishaw part number	Zeiss order number (* = Drilled ball)	d (mm)	L (mm)	D (mm)	ML (mm)	ds (mm)	B (mm)	Weight (gr)
M2 styli	1	A-5555-0314	602030-8017*	6	13	3				1
	2	A-5555-0315	602030-8018*	6	28	3				2
	3	A-5555-0316	602030-8019*	8	13	3				2

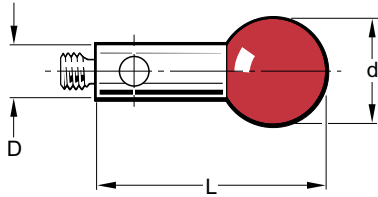

Part and description (schematic not shown to scale)	Item number	Renishaw part number	Zeiss order number	d (mm)	L (mm)	D (mm)	ML (mm)	ds (mm)	B (deg)	Weight (gr)
M2 pointed styli	1	A-5555-0317	602030-8342		10	3		1.5	30°	1
	2	A-5555-0318	602030-8343		10	3		1.5	60°	1

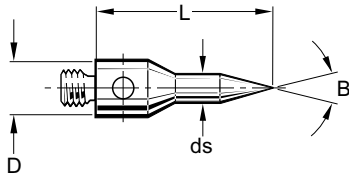

Part and description (schematic not shown to scale)	Item number	Renishaw part number	Zeiss order number	d (mm)	L (mm)	D (mm)	ML (mm)	ds (mm)	B (mm)	Weight (gr)
5-way stylus centre for M2 styli (large)	1	A-5555-0319	602030-9104		9.1	10.5			M2	4

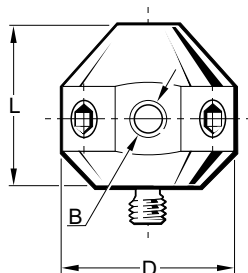

Renishaw adaptor elements for Zeiss RST probe systems with M2/M3 connecting thread



Part and description (schematic not shown to scale)

5-way stylus centre for M2 styli (small)

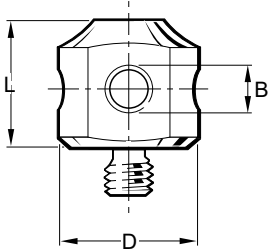

Item number	Renishaw part number	Zeiss order number	d (mm)	L (mm)	D (mm)	ML (mm)	ds (mm)	B (mm)	Weight (gr)
1	A-5555-0320	602030-9103		5.4	7			M2	1

Part and description (schematic not shown to scale)

M2 joint

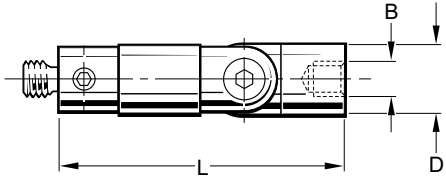

Item number	Renishaw part number	Zeiss order number	d (mm)	L (mm)	D (mm)	ML (mm)	ds (mm)	B (mm)	Weight (gr)
1	A-5000-9902	602030-9105		16.4	4			M2	2

Renishaw plc
New Mills, Wotton-under-Edge,
Gloucestershire, GL12 8JR
United Kingdom

T +44 (0)1453 524524
F +44 (0)1453 524901
E uk@renishaw.com
www.renishaw.com

RENISHAW 
apply innovation™

Renishaw applies innovation to provide solutions to your problems

Renishaw is an established world leader in metrology, providing high performance, cost-effective solutions for measurement and increased productivity. A worldwide network of subsidiary companies and distributors provides exceptional service and support for its customers.

Renishaw designs, develops and manufactures products which conform to ISO 9001 standards.

Renishaw provides innovative solutions using the following products:

- Probe systems for inspection on CMMs (co-ordinate measuring machines).
- Systems for job set-up, tool setting and inspection on machine tools.
- Scanning and digitising systems.
- Laser and automated ballbar systems for performance measurement and calibration of machines.
- Encoder systems for high accuracy position feedback.
- Spectroscopy systems for non-destructive material analysis in laboratory and process environments.
- Stylus for inspection and tool setting probes.
- Customised solutions for your applications.

Renishaw worldwide

Australia

T +61 3 9521 0922
E australia@renishaw.com

Austria

T +43 2236 379790
E austria@renishaw.com

Brazil

T +55 11 4195 2866
E brazil@renishaw.com

Canada

T +1 905 828 0104
E canada@renishaw.com

The People's Republic of China

T +86 10 8448 5306
E beijing@renishaw.com

Czech Republic

T +420 5 4821 6553
E czech@renishaw.com

France

T +33 1 64 61 84 84
E france@renishaw.com

Germany

T +49 7127 9810
E germany@renishaw.com

Hong Kong

T +852 2753 0638
E hongkong@renishaw.com

Hungary

T +36 (1) 70 381 4868
E hungary@renishaw.com

India

T +91 80 5320 144
E india@renishaw.com

Israel

T +972 4 593 6595
E israel@renishaw.com

Italy

T +39 011 966 10 52
E italy@renishaw.com

Japan

T +81 3 5332 6021
E japan@renishaw.com

The Netherlands

T +31 76 543 11 00
E benelux@renishaw.com

Poland

T +48 22 575 8000
E poland@renishaw.com

Russia

T +7 095 231 1677
E russia@renishaw.com

Singapore

T +65 6897 5466
E singapore@renishaw.com

Slovenia

T +386 1 52 72 100
E mail@rls.si

South Korea

T +82 2 2108 2830
E southkorea@renishaw.com

Spain

T +34 93 663 34 20
E spain@renishaw.com

Sweden

T +46 8 584 90 880
E sweden@renishaw.com

Switzerland

T +41 55 415 50 60
E switzerland@renishaw.com

Taiwan

T +886 4 2251 3665
E taiwan@renishaw.com

UK (Head Office)

T +44 1453 524524
E uk@renishaw.com

USA

T +1 847 286 9953
E usa@renishaw.com

For all other countries

T +44 1453 524524
E international@renishaw.com